

Technical Description

Example Of Temperature Control Configuration

The following example describes the basic configuration for temperature control.

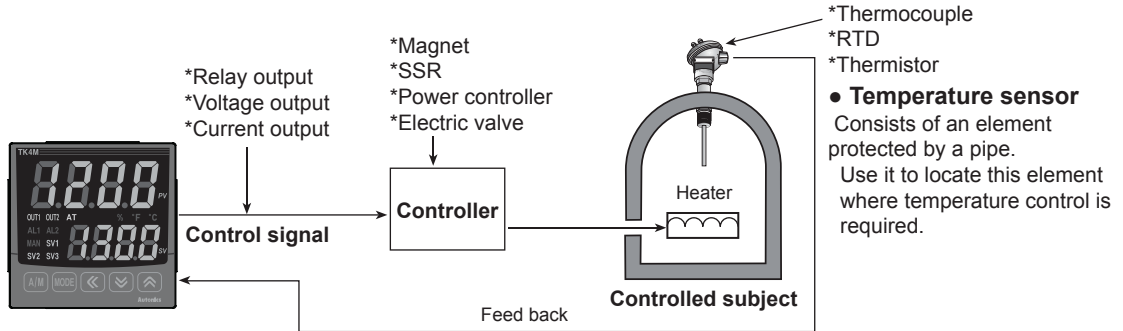

Temperature controller

Controls by receiving electrical signal input from temperature sensor and comparing the setting temperature value to provide adjustment signals for the controller.

Controller

Controls by heating or cooling. For example, a magnetic switch which opens/closes current for supplying heater or a solenoid valve which supplies the fuel.

Optimal Temperature Control

Optimal temperature control is that there is no overshoot, no hunting, no late response, and no influences on any external disturbances like figure (3). However, due to the characteristic of a controlled subject, optimal temperature control is hard to be realized. The fast response causes overshoot or hunting, reversely the slow response causes lots of time to reach the setting value. However, depending on the application, the desired control is different; like figure (1) fast control with overshoot, or figure (2) slow control without overshoot is able to be the desired temperature control. Therefore, optimal temperature control is various from application, and purpose. The figure (3) may be the general optimal temperature control.

(1) Fast response (the temperature stabilizes after overshooting several times)

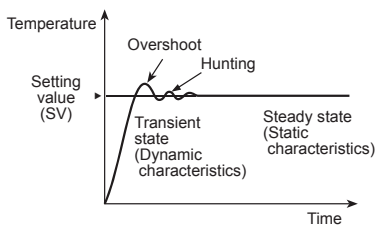

(2) The response that is slow in reaching the set point.

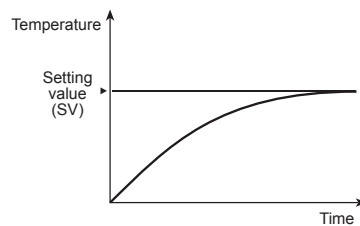

(3) Optimal temperature control

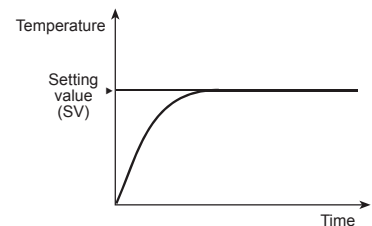

Characteristics Of The Controlled Subject

For the optimal temperature control, it is required to understand the thermal characteristics of the controlled subject before selecting a temperature controller or a temperature sensor.

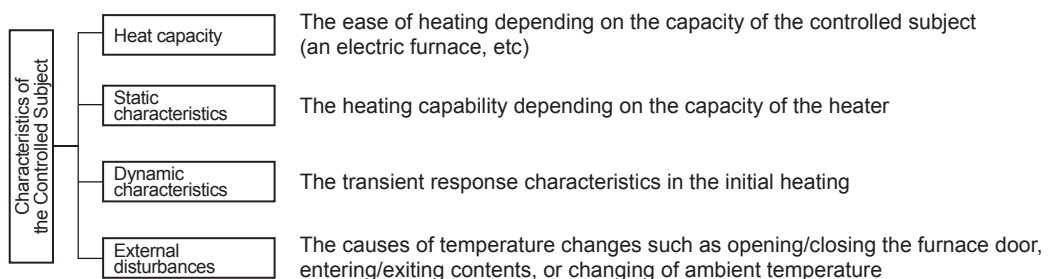

Temperature Control Operation And Characteristics

Operation	Advantages	Disadvantages
ON/OFF control	<ul style="list-style-type: none"> • Easy to control • Offset does not occur 	<ul style="list-style-type: none"> • Overshoot and hunting occur
Proportional control (P)	<ul style="list-style-type: none"> • Less overshoot and hunting 	<ul style="list-style-type: none"> • It takes time for the stable control • Offset occurs
Proportional Integral control (PI)	<ul style="list-style-type: none"> • Removes offset 	<ul style="list-style-type: none"> • It takes more time for the stable control than proportional control (P) (I control shall be used with P control.)
Proportional Derivative control (PD)	<ul style="list-style-type: none"> • Fast response to external disturbances 	<ul style="list-style-type: none"> • It cannot be controlled by itself. (D control shall be used with P control.)
PID control	<ul style="list-style-type: none"> • It is able to get an excellent control characteristics 	<ul style="list-style-type: none"> • It needs to set PID parameter.

ON/OFF control

If the present value is lower than the setting value, the output is turned ON and the heater power is supplied.

If the present value is higher than the setting value, the output is turned OFF and heater power is shut off. ON/OFF control operation is to ON/OFF heater power by comparing the present value and the setting value.

Like figure 1, exceeded temperature rise at start is overshoot, and the constant cycle based on the setting value is hunting.

Therefore, ON/OFF control operation is not appropriate to optimal control due to overshoot and hunting.

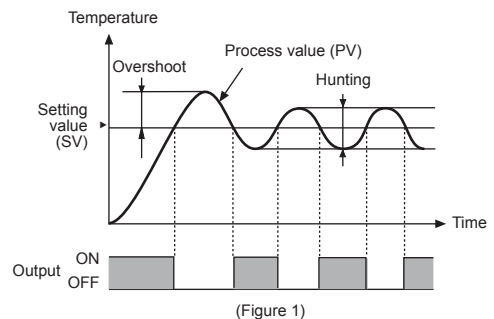

Hysteresis

For ON/OFF control, when ON, OFF control operates only at the setting value, output has oscillation and is subject to noise. Therefore, it should have ON, OFF section to operate ON, OFF at this section like figure 2. This section is called hysteresis.

For a freezer, hysteresis should be large enough because repeated ON/OFF control is hard on a compressor.

E.g.) If a temperature controller with temperature range of 0 to 400°C has 0.2 hysteresis ($D=F.S \cdot 0.2$ to 3%), hysteresis (D) is 0.8°C. If the setting value is 100°C, the output is OFF at 100.4°C and it is ON at 99.6°C.

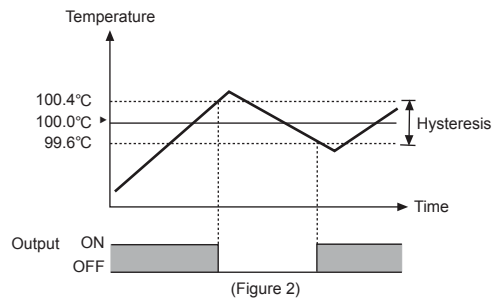

Proportional control (P control)

Proportional control (P control) has control output which is proportional to deviation from the present temperature to the setting value in the proportional band to the setting value.

Before the present value reaches A position, control output is ON at 100%. When the present value exceeds A position (lowest level of proportional band), the control output repeats ON/OFF operation in the proportional control cycle.

When the present value reaches setting value, control output is 50% and ON/OFF time ratio is 1:1. (If the present value exceeds the setting value, ON time of control output is short and OFF time is long.)

P control minimizes hunting of ON/OFF control. However, P control has long time to reach the set value and offset.

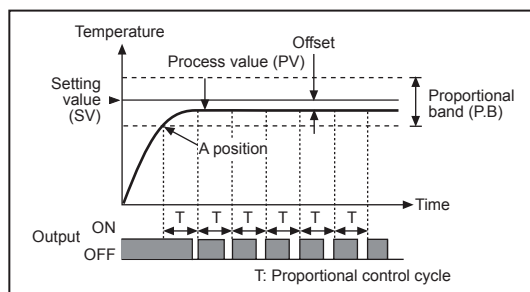
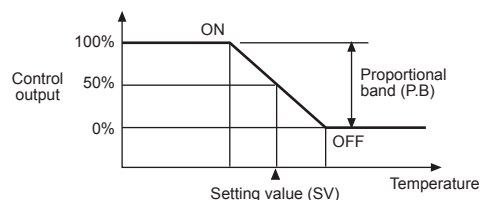

(A) Photoelectric Sensors

(B) Fiber Optic Sensors

(C) Door/Area Sensors

(D) Proximity Sensors

(E) Pressure Sensors

(F) Rotary Encoders

(G) Connectors/ Sockets

(H) Temperature Controllers

(I) SSRs / Power Controllers

(J) Counters

(K) Timers

(L) Panel Meters

(M) Tacho / Speed / Pulse Meters

(N) Display Units

(O) Sensor Controllers

(P) Switching Mode Power Supplies

(Q) Stepper Motors & Drivers & Controllers

(R) Graphic/ Logic Panels

(S) Field Network Devices

(T) Software

Technical Description

● Wide proportional band is set

Present value takes long time to reach the set value and has wide offset because control output operates ON/OFF at the below setting value.

● Narrow proportional band is set

Present value takes short time to reach the set value and has hunting because control output operates ON/OFF approaching the setting value.

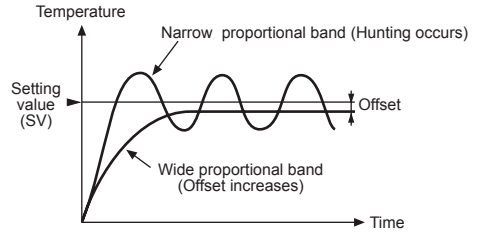

● Offset

In proportional control, there is certain error despite stable operation status by the heat capacity of controlled subject, or the heating capability.

This error is offset which occurs only in proportional control and is adjustable by reset volume. PID control removes offset automatically.

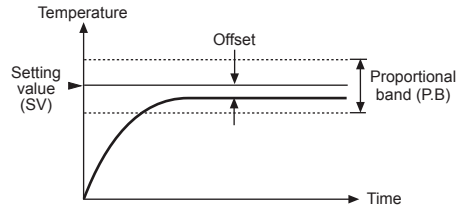

● Proportional control cycle and time-proportioning control

In the proportional control, control output with relay, SSR is turned ON for a set time period and is turned OFF for the left time.

This set time period is proportional control cycle and this control operation is time-proportioning control.

※Control cycle is fixed to 20 sec. in standard temperature controller.

※Control cycle is flexible to be changed from 1 to 120 sec. with PID temperature controller.

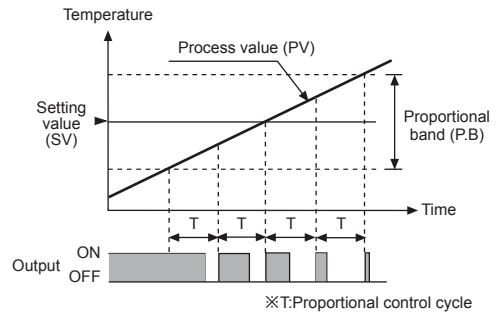

◎ Proportional integral control (PI control)

Integral action automatically adjusts the offset of proportional control to control stably at the setting value. However, it takes long time to stabilize the temperature changes about the external disturbances.

Integral action cannot be operated by itself, it shall be operated with P control.

- The shorter reset time, the stronger integral action is. It adjusts offset for shorter time but causes hunting.
- The longer reset time, the weaker integral action is. It takes longer time to remove offset.

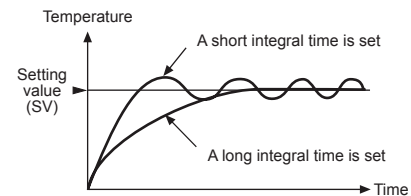
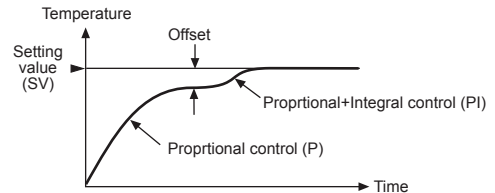

● Reset time

Reset time, the unit of intensity of integral action, is the taking time to coincide with the control output of integral action and the control output of proportional action.

Too short integral time causes the strong integral action and hunting.

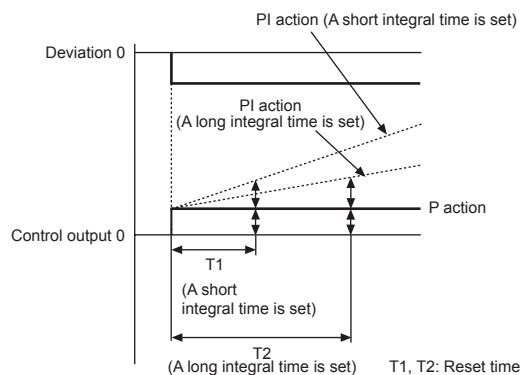

⊙ Proportional derivation control (PD control)

Comparing with proportional control, proportional derivative control has fast response to temperature changes about the external disturbances.

Derivation control adjusts with the control output which is proportional to the slope of temperature changes. Therefore, derivation control stabilizes the temperature changes with high control output to the external disturbances.

- The shorter rate time, the weaker derivation action responds slowly to external disturbances. Therefore, it takes longer time to reach the setting value but there is no hunting.
- The longer rate time, the stronger derivation action response quickly to external disturbances. Therefore, it takes shorter time to reach the setting value but it is easy to occur in hunting.

● Rate time

Rate time, the unit of intensity of derivative action, is the taking time to coincide with the control output of the derivative action and the control output of proportional action when the deviation is ramp type.

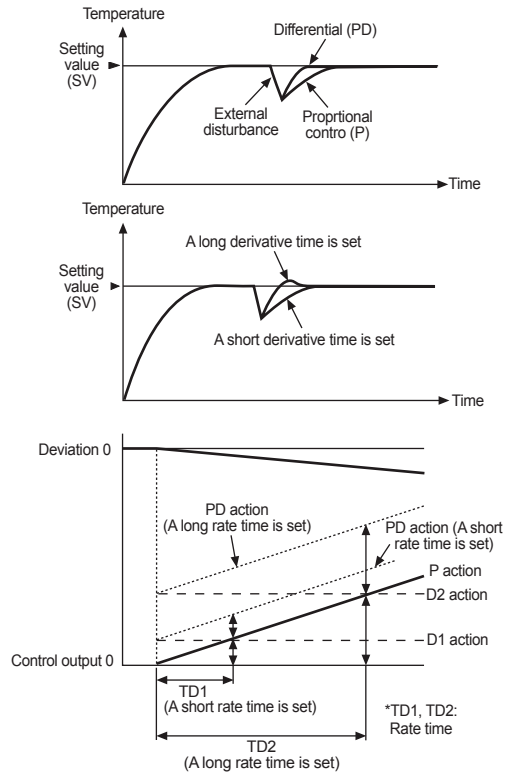

⊙ PID control (Proportional + Integral + Derivation control)

PID control combined with proportional, integral, and derivation control modes has good control output to a controlled subject which has delay time.

PID control does not have overshoot and hunting of proportional control (P control), adjusts automatically offset of integral control (I control), and has fast response to external disturbance with derivative control (D control). As the result, PID control is realized optimal temperature control.

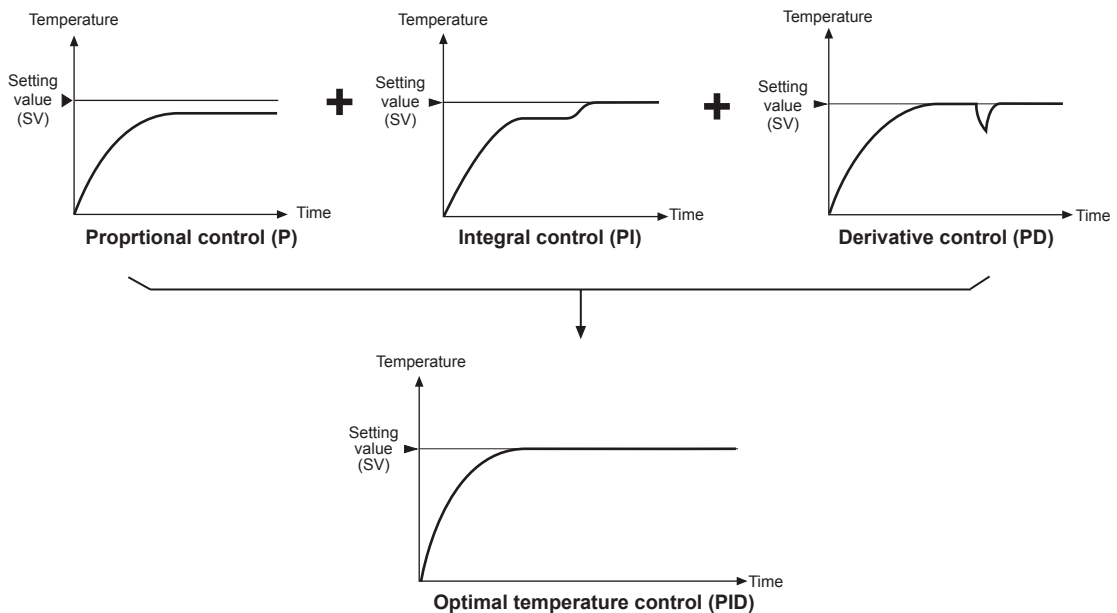

(A)	Photoelectric Sensors
(B)	Fiber Optic Sensors
(C)	Door/Area Sensors
(D)	Proximity Sensors
(E)	Pressure Sensors
(F)	Rotary Encoders
(G)	Connectors/ Sockets
(H)	Temperature Controllers
(I)	SSRs / Power Controllers
(J)	Counters
(K)	Timers
(L)	Panel Meters
(M)	Tacho / Speed / Pulse Meters
(N)	Display Units
(O)	Sensor Controllers
(P)	Switching Mode Power Supplies
(Q)	Stepper Motors & Drivers & Controllers
(R)	Graphic/ Logic Panels
(S)	Field Network Devices
(T)	Software

Technical Description

■ Control Outputs

◎ Relay output

Relay output is used to control the ON/OFF operation of subject devices through the built-in relay contact.

◎ SSR drive output

SSR drive output releases DC voltage as an output to control SSRs (solid state relay: non-contact relay).

Using solid state relays can help maintain a small configuration size and achieve a semi-permanent life cycle.

- SSRP function (only TK, TCN, TC Series)
SSRP output is selectable one of standard ON/OFF control, cycle control, phase control by utilizing standard SSR drive output.

◎ Current output

A current output is a control output used to drive an external power controller (SCR UNIT), control valve, etc.

It is also called analog output, and the output is stable and does not have rapid change, and it can process a stabilized control.

(e.g.) current output 4-20mA of TZ/TZN Series

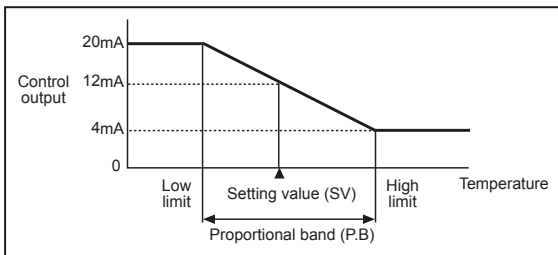

◎ Transmission output

It is not for controlling but for transmitting PV to outside.

Generally, PV is transmitted as current.

In case of transmission output DC 4-20mA, it outputs DC 4-20mA within the set high/low-limit range.

(e.g.) transmission output DC 4-20mA, resolution 16,000 of TZ/TZN Series

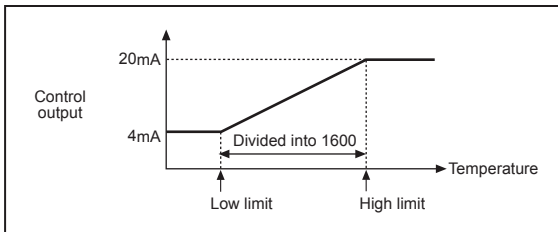

◎ RS485 communication function

By RS485 communication, data of temperature controller is transmitted or set to external devices. You can set communication address, speed, parity bit, stop bit, response waiting time, write enable/disable of the temperature controller.

■ Glossary

◎ Deviation

It means the deviation of the controlled value from the setting value.

◎ Burn out function

Output turns OFF when sensor is disconnected. It is the thermal response time of heater and is percentage constituents.

$$\text{Thermal response} = \frac{\text{Fall time}}{\text{Rise time} + \text{Fall time}} \times 100 (\%)$$

◎ Linearize

Non-linear response to changing temperature needs to be revised and this modification is called linearize.

Uneven gradations to linearize analog temperature controller, linear analyze circuit to linearize thumbwheel switch type temperature controller.

■ Temperature Sensor

Temperature can be simply classified into two groups, contact and non-contact. Most of sensors such as platinum resistance thermometer, thermistor, thermocouple, etc. are contact temperature sensors, and it literally contacts with object to infer the temperature.

◎ Platinum resistance thermometer (RTD: Resistance Temperature Detector)

The electrical resistance of the metal used by platinum resistance thermometers has a fixed relationship to the temperature. Therefore, a platinum wire is used for the resistor. The most reproducible temperature sensor, platinum RTD has a near linear positive temperature coefficient from -260 to 630°C. In this reason, RTDs are used as industry standard.

Sensor is put in protecting tube charged with insulation and widely used for dyeing, physical/chemical appliances, controlling processor, but it is somewhat expensive.

● Standard Platinum Resistance Thermometer

Symbol	Resistance
Pt100	100Ω
Pt50	50Ω

※Resistance is specified by its value at 0°C.

※Resistance fluctuation per 1°C

• DIN Pt (the German Institute for Standardization): 0.385Ω/°C

• JIS Pt100 (Japanese Industrial Standard): 0.3916Ω/°C

◎ Thermistor

A thermistor is a semiconductor device with an electrical resistance that is proportional to temperature, and there are two types, PTC (Positive Temperature Coefficient) and NTC (Negative Temperature Coefficient).

It is mostly used for assembling machines, inexpensive and small. But they are incompatible and non-linear.

And so circuits cannot be used for an industrial purpose or in circumstances where compatibility with sensor is required. NTC is used for temperature sensing/controlling, liquid/wind/vacuum level detecting, inrush current preventing, retardation element, etc., and PTC is for motoring, degaussing, heating a fixed temperature, overcurrent device, etc.

◎ Thermocouple

Thermo electromotive force is provoked when providing temperature for the junction of the difference metals which is joined and welding. This thermo electromotive force has the certain value depending on temperature changes.

Thermocouple sensor is generally used for industrial use such as the steel, power plant, or heavy chemical industry. However, thermocouple's accuracy is not higher than platinum RTD and thermocouple is able to be expensive than platinum RTD because thermocouple requires compensating lead wires.

※Depending on the kind of metal, thermocouple has different thermo electromotive force.

※Material codes and temperature range.

- K (CA): -100 to 1300°C
 - J (IC): 0 to 800°C
 - R (PR): 0 to 1700°C
 - E (CR): 0 to 800°C
 - T (CC): -200 to 400°C
 - S (PR): 0 to 1700°C
 - N (NN): 0 to 1300°C
 - W (TT): 0 to 2300°C
- *Former models name in parenthesis.

● Sheathed thermocouple

Sheathed thermocouple consists of sheath, and sealed insulator of high magnesium with element wire.

Sheathed thermocouple has fast response of temperature changes, high resistance, high corrosion-resistance, and high pressure-resistance.

● Grounded

Grounded type which is welded element wires and sheath directly has fast response. It is suitable to measure high temperature and pressure. However, it which is non insulated has a limit on various applications.

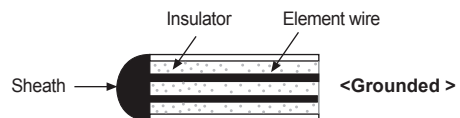

● Ungrounded

Ungrounded type which is completely insulated between element wires and sheath has slow response. However, it has small impact on external factors such as corrosion, high pressure, or high temperature. Due to this reason, it is suitable for prolonged use.

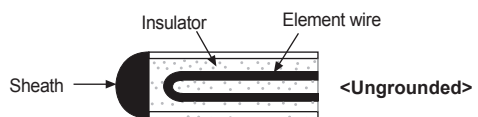

● Exposed

Exposed type which consists of exposed element wires to the sheath has the fastest response among three sheath types. However, it which has low mechanical intensity is not suitable for corrosive, high pressure, or high temperature environment.

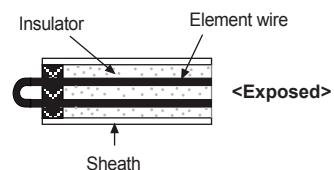

(A) Photoelectric Sensors

(B) Fiber Optic Sensors

(C) Door/Area Sensors

(D) Proximity Sensors

(E) Pressure Sensors

(F) Rotary Encoders

(G) Connectors/ Sockets

(H) Temperature Controllers

(I) SSRs / Power Controllers

(J) Counters

(K) Timers

(L) Panel Meters

(M) Tacho / Speed / Pulse Meters

(N) Display Units

(O) Sensor Controllers

(P) Switching Mode Power Supplies

(Q) Stepper Motors & Drivers & Controllers

(R) Graphic/ Logic Panels

(S) Field Network Devices

(T) Software

Technical Description

● Cold junction compensating circuit

When connecting a thermocouple and input terminal of temperature controller, thermo electromotive force is provoked on a point of contact between a thermocouple and input terminal metal. The thermo electromotive force causes a temperature error, and for correcting this the temperature of the point should be maintained 0°C.

However, it is hard to be maintained at 0°C. Because of this reason, the point of contact has an individual temperature sensor to detect the temperature of the point. Sensing circuit subtracts this temperature for correcting error, and this circuit is called cold junction compensating circuit. Most of temperature controllers have integrated cold junction compensating circuit.

● Compensating lead wire

These are compensating lead wires used when the temperature measurement point and the temperature controller are far apart.

1) Purpose of compensating lead wire using

The principle of thermocouple temperature sensor is that after joining and welding two difference metals, thermo electromotive force is provoked when providing temperature on the junction.

Thus, in case of the distance between the thermocouple and the temperature controller is too long, compensating lead wires are required. Using normal wire extension can cause an error, because a connecting point could be another sensor. For this reason, consider the construction and resistive value. The compensating lead wires consist of materials that match the potential difference of the thermocouple to be use.

2) Polarity of compensating lead wire

There are two wires, red color wire for phases and blue one for neutral (white or black).

Please note that, if compensating lead wire polarity is unmatched, it generates error.

E.g.)Use K type thermocouple compensating lead wire for K type thermocouple.

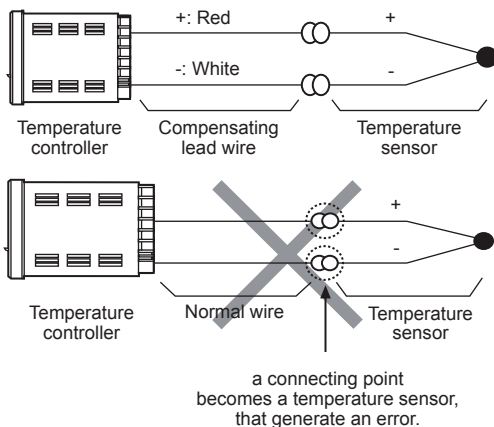

■ Proper Usage

◎ Caution during use (Common features)

- Use the regulated compensating lead wire only. Because a connecting point where normal wire and thermocouple wire joined together could be another sensor, using normal wire for extension can cause an error.
- 3-wire circuit connection is required for RTD sensor. Compensating wire that is the same length and diameter as the sensor wire is compulsory in using RTD sensor. Two different metal wires cause two different temperature values.
- Input signal wire is needed to be placed in an area that does not get much noise from wires around such power, loads, etc.
- If it is unavoidable for input signal wire to be placed near power line, line-filter capacitors are required to be set at power line of controller, and use shield wire for signal input line.
- Avoid using near devices that make high frequency noise (high frequency welder/sewing machine, large-capacity SCR controller).

◎ Simple "error" diagnosis

● Incorrect temperature indicated.

Inspect input part in priority in this case. To find out at which part has problems if using thermocouple, disconnect the sensor from input terminal and check if it shows the room temperature on the display. And also, if using RTD type, make sure that if all the wires are 3-wire, the same diameters. Using 2-wire or 3-wire that different diameter, temperature deviation occurs.

● Controlled temperature differs from SV when operation finished

Thermal response time of heater or controlled subject could be the problem in this case. Rearrange Reset VR on the front side of controller so that the deviation disappears.

● Oscillating output relay

Which happens when back electromotive force generated from external magnet S/W comes in through power line or strong high-frequency device is being used nearby.

Be far away from high-frequency devices. And stay two power lines, magnet S/W power's and controller's, apart from each other. If it is hard to rearrange track, add mylar condenser, 0.1 μ F/600V or 1 μ F/600V, on power terminal of external magnet S/W to remove oscillating.

● Being observed right temperate in a room temperature but wide temperature deviation occur in high temperature,

Check out if the sensor type is correspond with temperature controller. (It can be the problem of sensor characteristics)

Technical Description

Product System

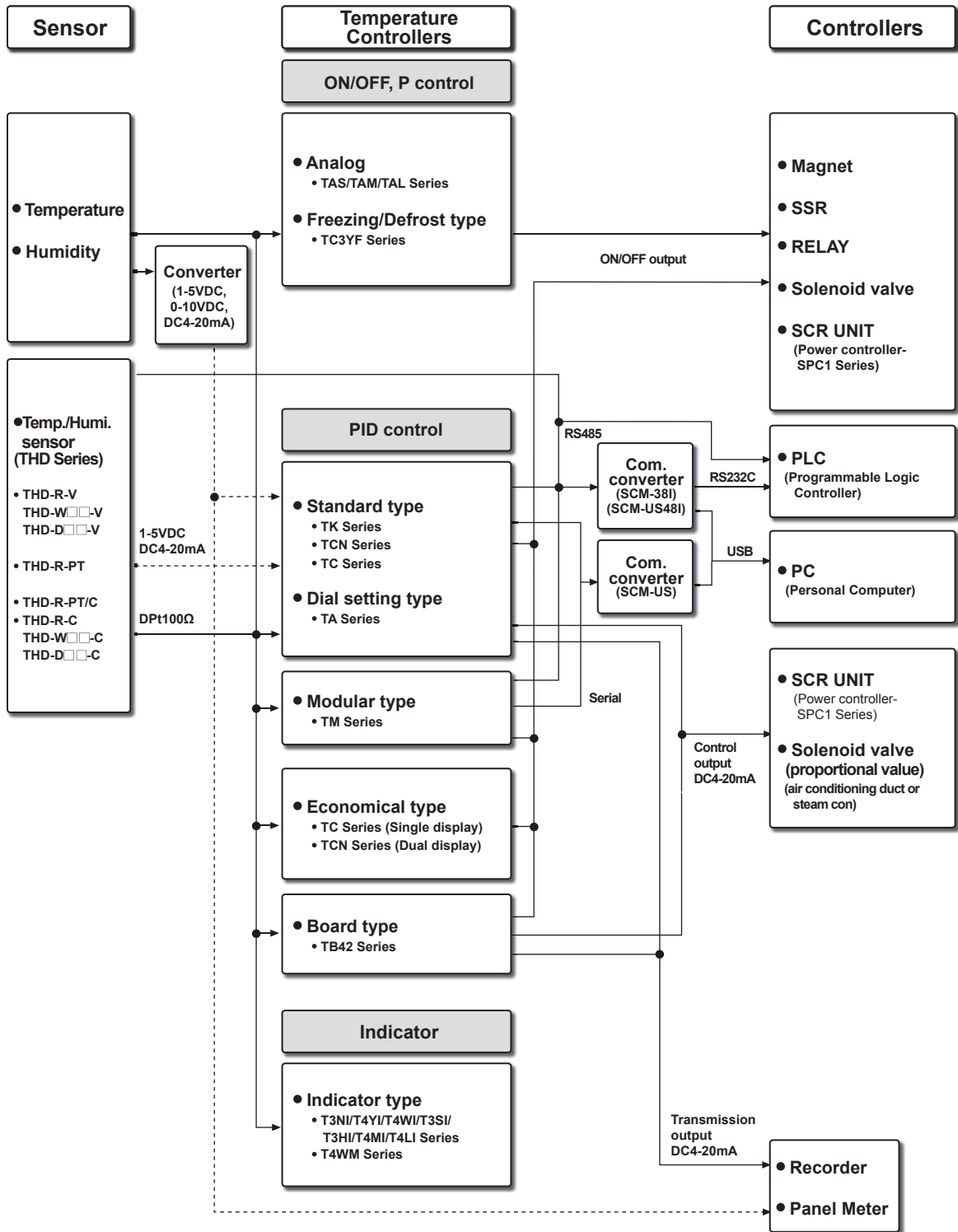

- (A) Photoelectric Sensors
- (B) Fiber Optic Sensors
- (C) Door/Area Sensors
- (D) Proximity Sensors
- (E) Pressure Sensors
- (F) Rotary Encoders
- (G) Connectors/ Sockets
- (H) Temperature Controllers
- (I) SSRs / Power Controllers
- (J) Counters
- (K) Timers
- (L) Panel Meters
- (M) Tacho / Speed / Pulse Meters
- (N) Display Units
- (O) Sensor Controllers
- (P) Switching Mode Power Supplies
- (Q) Stepper Motors & Drivers & Controllers
- (R) Graphic/ Logic Panels
- (S) Field Network Devices
- (T) Software